

INSTALLATION GUIDE

AeraMax® PRO Air Quality Control System: AM III

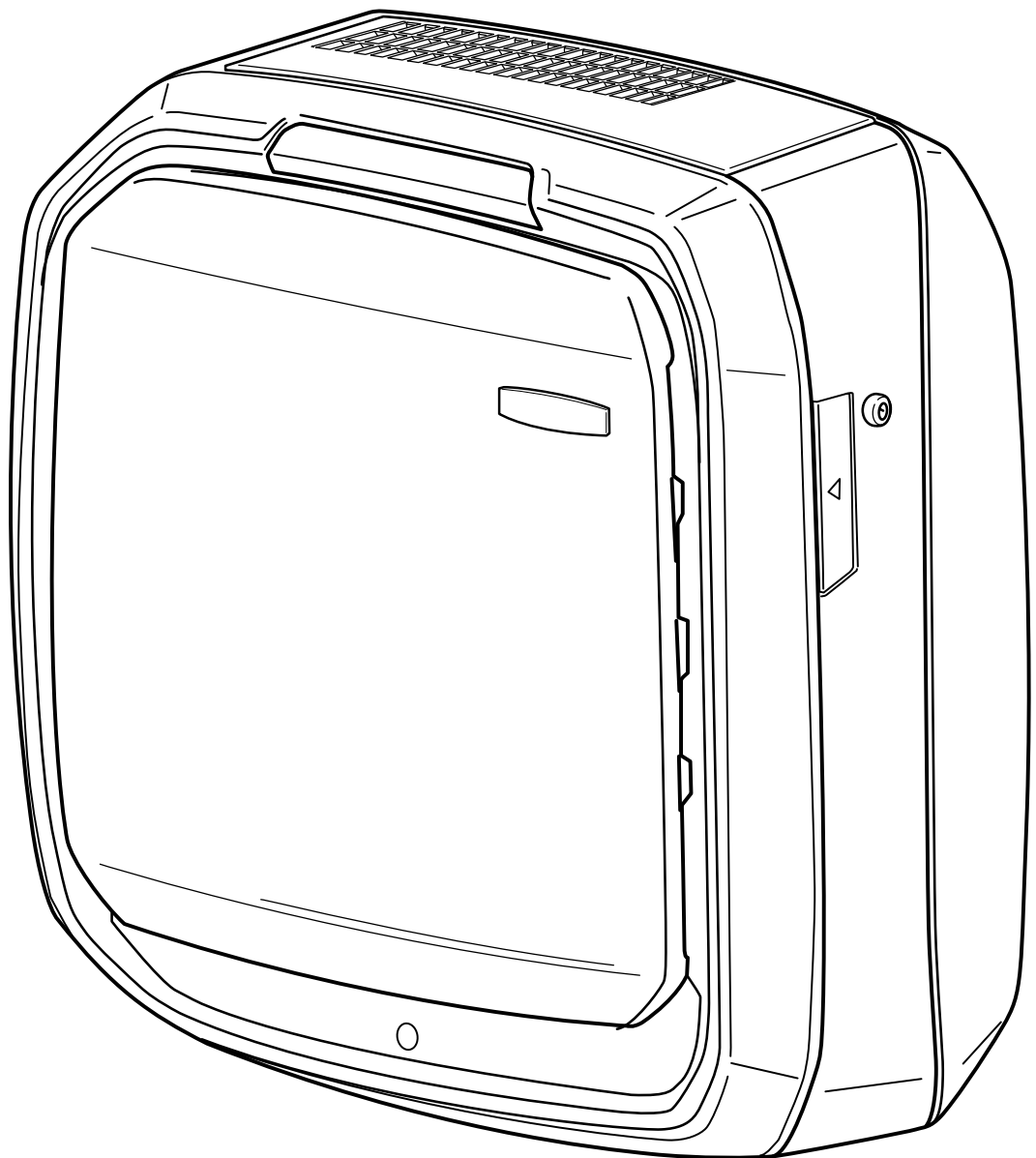

Please read instructions carefully before installing unit

KEY

- 1. Access panel
- 2. Filters
- 3. Filter frame
- 4. Main Assembly
- 5. Power Switch
- 6. Access panel latch
- 7. Access panel lock
- 8. Rear housing assembly
- 9. Control panel
- 10. Filter frame window

Fig 1

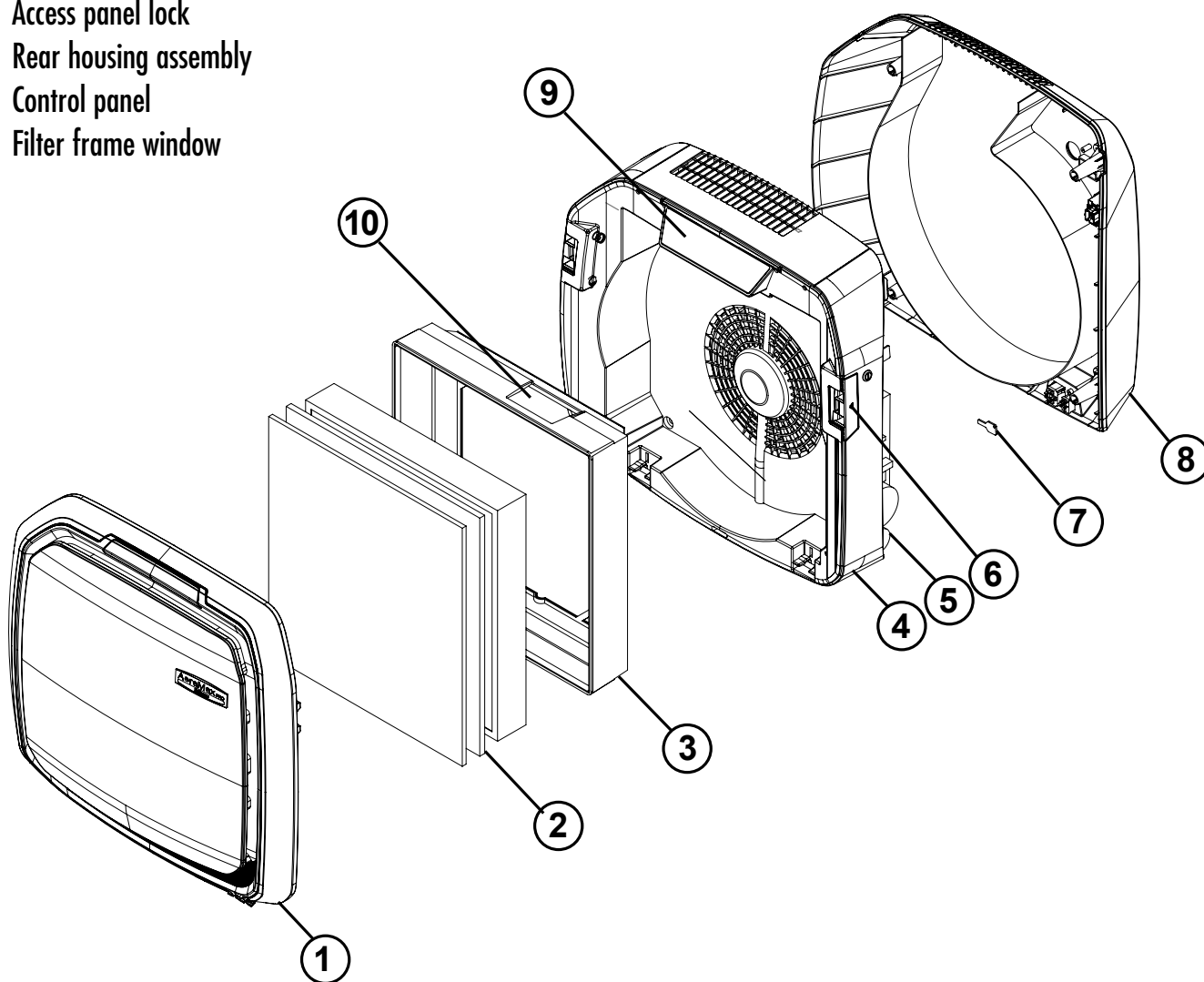

SAFETY

WARNING: To avoid the risk of electrocution confirm the electrical supply has been disconnected or switched off before beginning any installation work.

Confirm no electrical wiring, utility pipes, or duct work is located directly behind the installation / drilling area.

On a stud wall, it is strongly recommended at least 2 mounting anchors for the air purifier be mounted to an existing stud.

TOOLS REQUIRED FOR INSTALLATION

- Electric drill, drill bits (not included)
- # 2 Phillips and # 2 Flat Head screw drivers (not included)
- Wire nuts (not included)
- Level (not included)
- Mounting template (included)

PARTS PROVIDED FOR INSTALLATION

- Drywall Anchors - 10mm OD
- Pan Head Phillips Screws

PRODUCT INSTALLATION GUIDELINES

Place the mounting template provided on the wall where the air purifier is to be installed. If air purifier is being mounted high on the wall make sure the top edge of the unit is positioned at least 8" inches (21 cm) below the ceiling to allow for filter replacement (see Fig 2).

Americans with Disabilities Act (ADA):

Be sure to follow all ADA guidelines pertaining to "Objects protruding into a circulation path." For more information visit www.ada.gov.

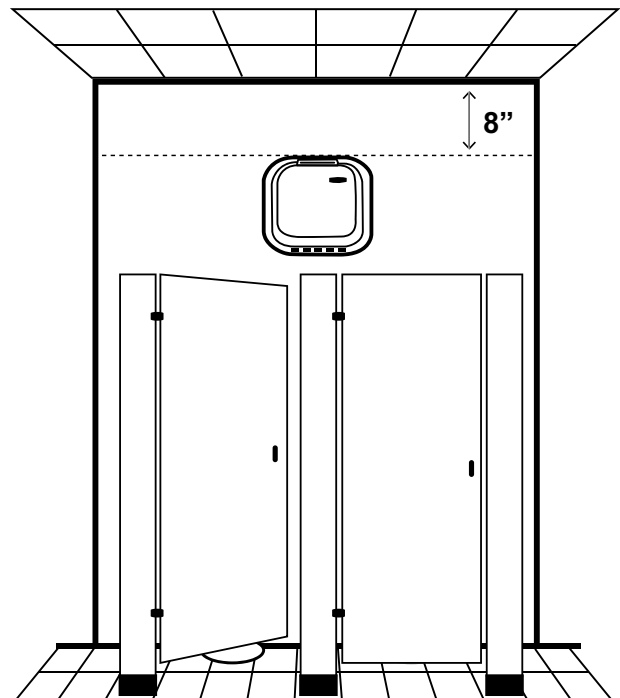
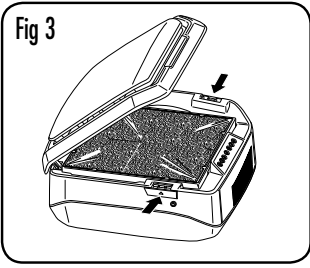

Fig 2

MOUNTING REAR HOUSING AND MAIN ASSEMBLY

Test the electrical outlet box first to ensure rated power requirements are met before beginning installation.

Remove air purifier from its shipping carton and remove all packing material.



Place the air purifier face up on a flat, stable work surface. Open the access panel by pressing in latches on each side of the unit (Fig 3).

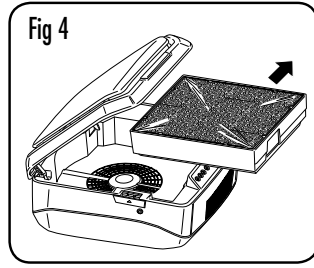

Open access panel and remove filter assembly by pulling out on top of side edges of frame, then lifting. NOTE: remove all plastic wrap from filters (Fig 4).

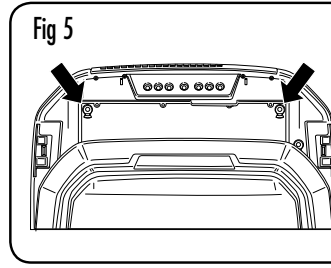
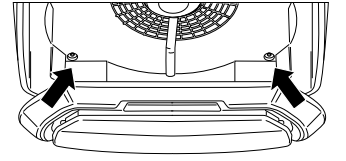
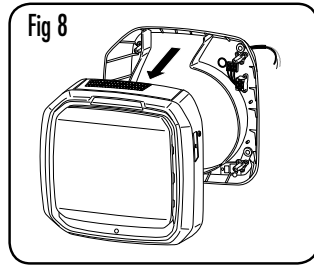
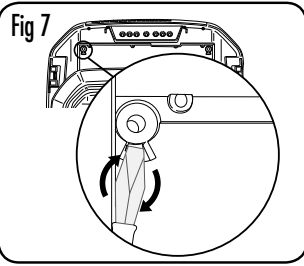

Fig 6



Remove the four housing screws (Fig 5 & 6) and set aside for re-assembly.



At the location of the two upper housing screws (Fig 5), insert a flat head screwdriver and gently twist to release tab as shown in Fig 7. This will disconnect main housing assembly from the rear housing assembly.

Disconnect main housing assembly from rear housing assembly. Separate main housing from rear housing. Lift main housing assembly away from rear mounting housing (Fig 8).

REAR HOUSING INSTALLATION & WIRING

Reference rear housing and locate desired mounting location. Again, it is strongly recommended at least 2 mounting anchors for the air purifier be mounted to an existing stud.

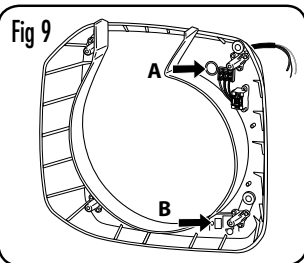

Using provided template ensure electrical outlet box is located behind cable hole (A) in Rear Housing assembly (Fig 9). Drill holes and place anchors in wall.

If mounting on concrete, cinder block or brick type walls route the wires through the "punch-out" hole marked (B) in Fig 9.

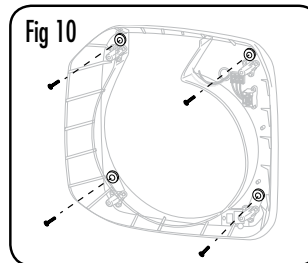

Check for washers at all mounting screw locations (Fig 10). Pull wires from electrical outlet box through hole in rear housing. Align housing over anchors and securely install all mounting screws.

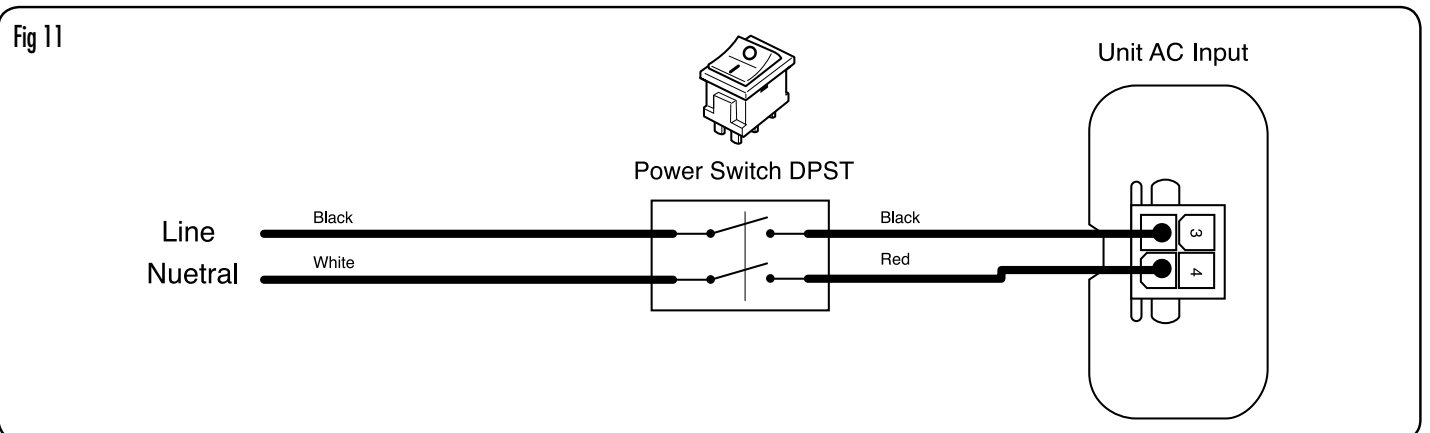

Attach wires from electrical outlet box to wires located inside rear housing using wire nuts. Match up line (black) and neutral (white) wires (Fig 11). Make sure all connections are made in accordance with federal, state and local codes and regulations.

MAIN ASSEMBLY INSTALLATION

WARNING: To avoid the risk of electrocution confirm the electrical supply has been disconnected or switched off before continuing any installation work.

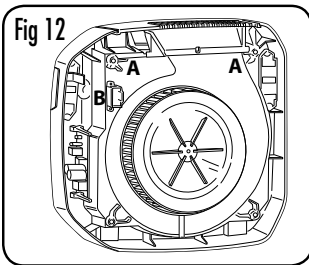

The power connector (B, in Fig 12) will carry power from the rear housing to the main housing once the assemblies are fully seated. The main assembly will attach to the rear housing assembly by the four screws previously removed (Fig 5 & 6). Two snap hooks (A, in Fig 12) will hold the main and rear assemblies together until the screws can be installed.

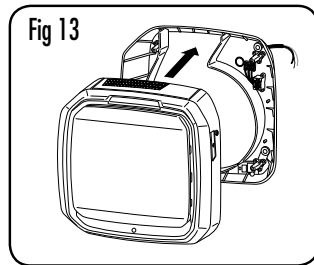

Carefully align the main assembly with the rear housing assembly. Slowly press into place until snap is heard, and there is no gap between the assemblies (Fig 13). The unit should now support its own weight.

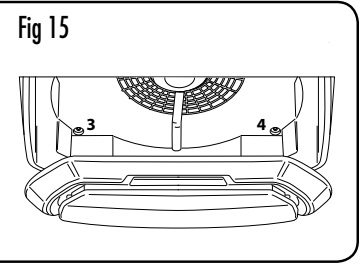
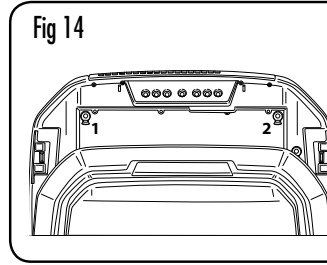

Install four screws (previously removed) to secure main assembly to rear housing assembly (Fig 14 & 15).

RE-INSTALLING FILTERS

IMPORTANT: Make sure all plastic wrap is removed from filters.

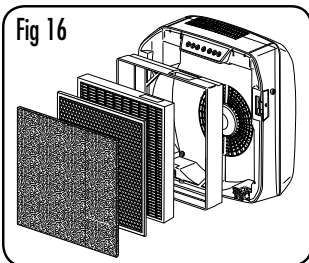

Make sure filters are in correct order - pre-filter / carbon filter / HEPA filter - and inserted into filter frame (Fig 16).

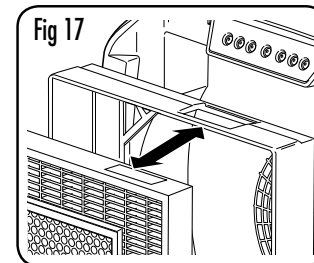

IMPORTANT: Make sure filter detection area aligns with window in filter frame (Fig 17).

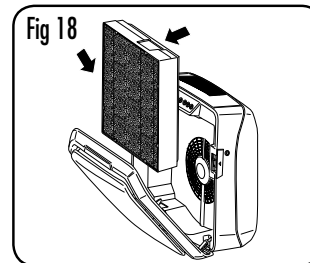

Open front panel by pressing latches on both sides of unit. Allow door to open fully. Insert filters - **IMPORTANT:** make sure filter detection window is aligned in upper right corner (Fig 18).

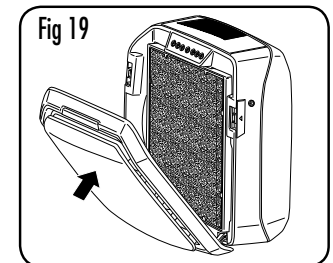

Close front panel by pressing firmly until both sides latch closed (Fig 19).

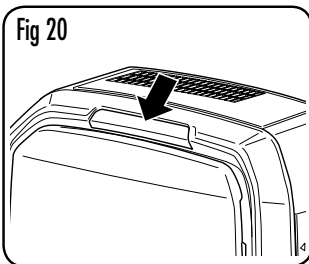

Once the unit is closed re-establish power. Lights on the control panel will be visible through the lens, indicating the unit is operational (Fig 20). The power light indicator will flash once a second.

LOCKING ACCESS PANEL

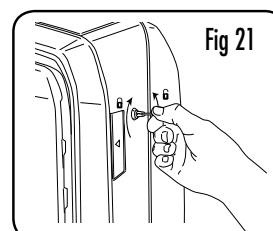

To restrict access to the control panel and filters the unit can be locked. To lock, insert the key provided and rotate clockwise $\frac{1}{4}$ turn (Fig 21).



Fellowes, Inc.

1789 Norwood Ave

Itasca, Illinois 60143-1095 USA

630-893-1600

1-800-477-7940

Product Support: 1-800-945-4545

www.aeramaxpro.com